

## Connect the dots

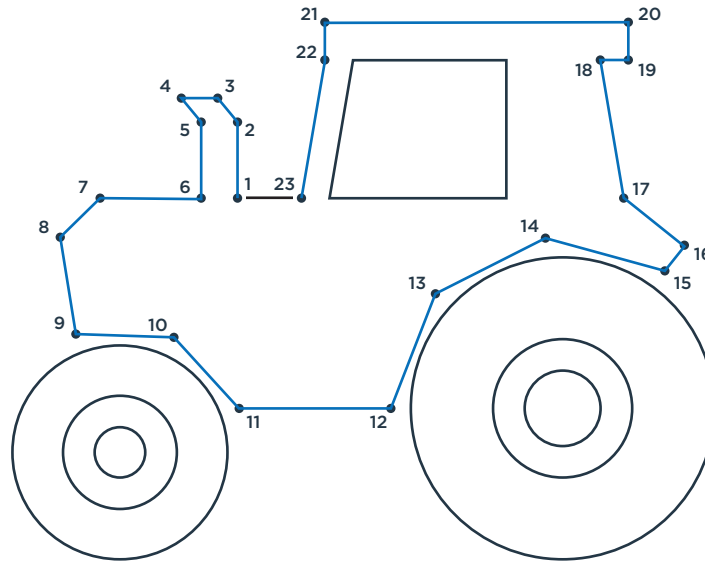

# Answer key

## Color me

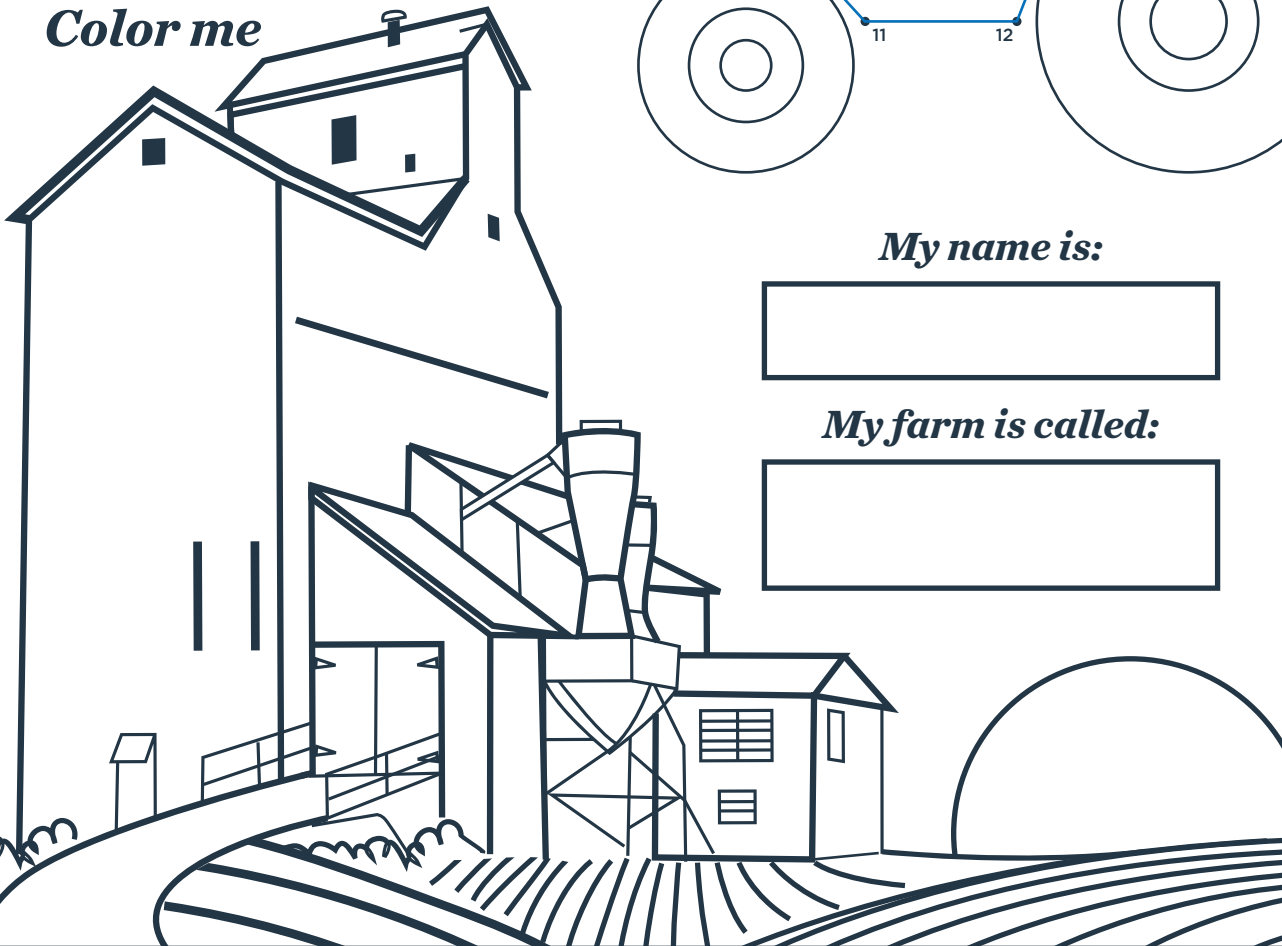

My name is:

My farm is called:

## Maze

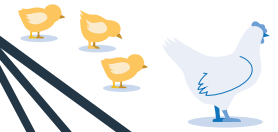
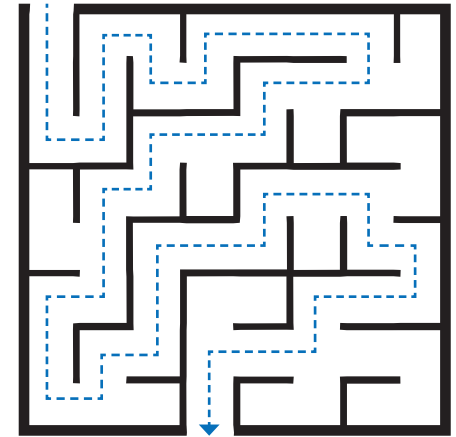

## Word find

L	C	X	B	S	M	N	O	S	D	N	V	L	D	J
I	A	Z	A	F	I	E	S	T	T	B	X	O	G	R
R	E	M	R	A	F	T	L	N	I	L	U	C	S	N
W	Z	X	R	M	A	D	E	E	V	Y	B	K	R	R
S	A	G	X	Y	N	M	S	M	V	Q	H	O	H	E
U	O	G	O	J	F	S	Q	P	V	A	M	U	Y	P
S	O	U	O	L	P	W	B	A	G	L	T	T	Q	P
E	T	Y	U	N	K	A	L	R	D	B	L	O	L	O
P	S	G	Y	X	Q	K	M	T	Q	N	Y	R	R	H
U	N	G	K	K	J	I	S	N	Y	B	C	J	L	V
E	G	X	D	E	C	U	O	E	X	T	H	O	K	X
R	E	F	V	K	Y	A	U	G	E	R	E	J	J	A
R	R	D	U	S	T	M	A	S	K	G	D	F	F	V
J	Z	E	N	Y	T	T	I	E	P	C	F	B	A	E
O	H	P	O	Q	N	X	D	T	X	X	M	Y	S	

# ANSWER KEY



Climbing is fun, but not on a silo or grain bin! Although they are impressive structures, it's best to view these with both feet on the ground.



Stay clear of all loading or unloading grain trucks. Although it is an exciting process to be a part of, this task is best handled by an ops manager or farm supervisor. Accidents during this process are common and sometimes even fatal.



It's important to steer clear of all augers, especially during the unloading process. Clothing, jewelry, footwear and even limbs can be pulled into the mechanism.



Tractors and grain wagons are always on the move, so don't play in, on or around them. Hitching a ride is also a dangerous way to get around, so grab your bike instead.



Be sure to keep an eye out for signs like these. Grain dust can pose a respiratory hazard. Grain that is out of condition or deteriorating can release toxic gases and create an oxygen-deficient atmosphere. Always wear a mask if instructed to do so.



Grain bins should not be confused with a tree house or fort. Playing in and around grain bins could cause an unfortunate accident or worse. Bring a buddy, but playing hide-and-go-seek in your backyard is a safer game.



Stay away from large grain piles and flat-houses. Grain could be dangerous and out-of-condition; flowing grain can also pose as a serious engulfment hazard. Like quicksand, flowing grain will pull a fully grown person to waist level in less than a minute. Once you have grain above your knees, there's almost no chance of escape without assistance.



MASK MUST  
BE WORN  
AT ALL TIMES